

# COLORING ACTIVITY BOOK

## FOR FUTRE SKATEPARK DESIGNERS

FOR AGES  
2-12

FIND ME,  
I'M ON EVERY  
PAGE!

INCLUDES:  
8 COLORING PAGES  
CUT-OUTS  
LEARN TO DRAW IN 3D  
MAZES  
SEARCH + FIND  
MATH CHALLENGE

 Tag @dugoutdesignstudio to show us your work!

Illustrations by Dug Ketterman

**DUGOUT**<sup>®</sup>  
designstudio

© 2020 DugOut Design Studio, LLC. All Rights Reserved.



# BOX JUMP

Color  
Me!

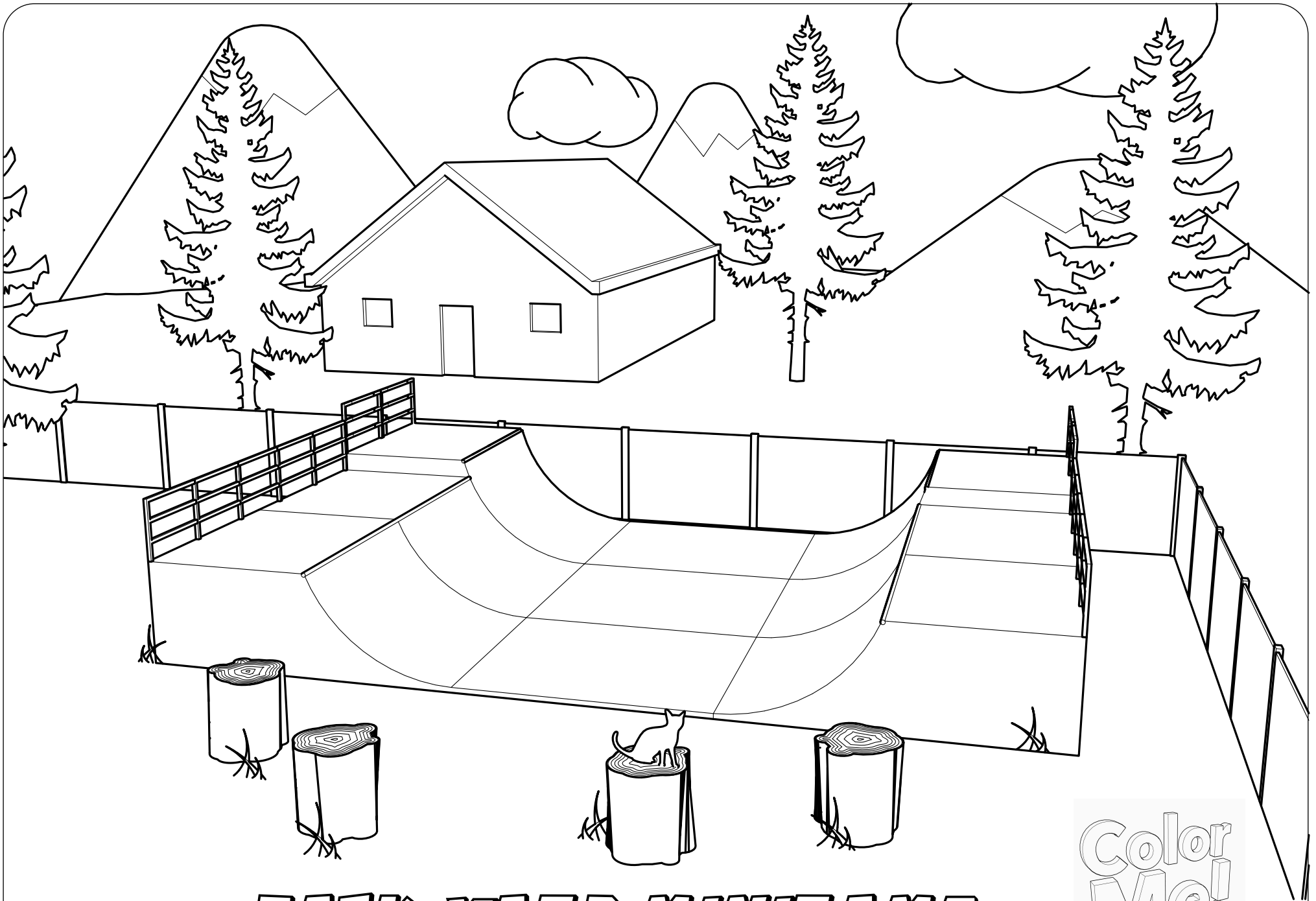

**DUGOUT.**  
designstudio

# BACK YARD MINIRAMP

Color  
Me!

© 2020 DugOut Design Studio, LLC. All Rights Reserved.

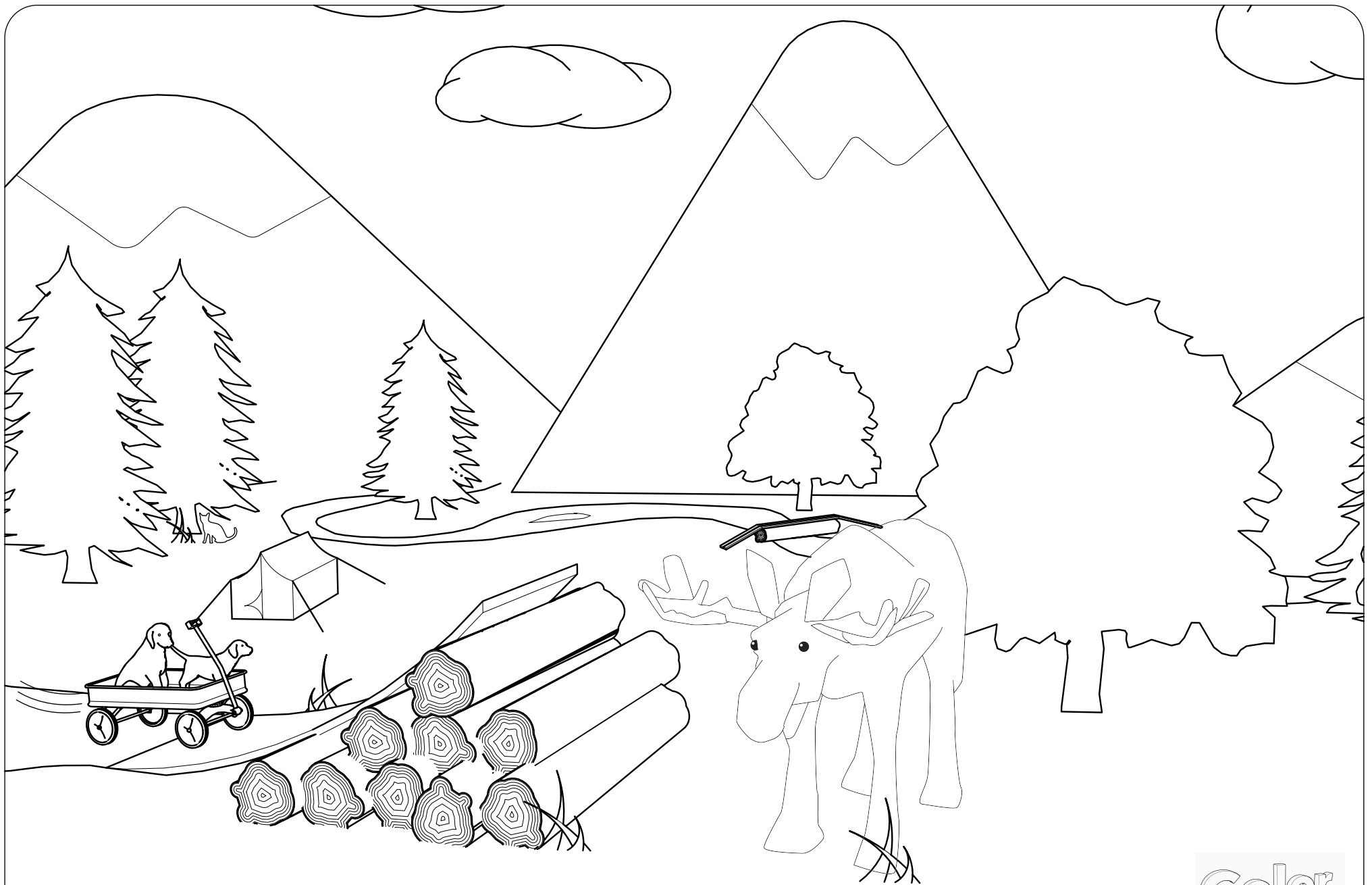

# JUMP THE MOOSE

**DUGOUT.**  
designstudio

Color  
Me!

# WORD SEARCH

B	I	K	E	J	Z	E
R	U	N	N	U	H	S
O	A	R	Q	M	W	K
W	T	M	D	P	T	A
A	I	R	P	E	Y	T
O	L	P	C	Y	O	E
D	I	R	T	Y	U	Q

**BIKE** 

**RAMP**

**AIR**

~~**DIRT**~~

**SKATE**

**JUMP**

# WORD SEARCH (PRO LEVEL)

G	U	F	E	W	Z	E	S	T	T	G	N	U	M	I	N	M	S	J
B	U	N	N	Y	H	O	P	P	H	K	E	P	R	T	P	M	K	M
O	N	R	Q	A	W	W	E	O	X	R	A	I	R	O	P	I	A	R
W	T	H	D	Z	T	S	G	L	W	H	D	U	N	U	D	M	T	I
V	E	R	T	E	Y	T	R	L	D	K	C	R	X	R	G	R	E	D
O	L	P	C	Y	O	E	B	I	L	T	T	W	L	F	L	K	B	E
A	U	C	R	Y	U	E	U	E	K	E	E	H	J	C	E	U	O	R
U	E	M	B	I	K	E	R	T	G	T	U	O	G	U	D	T	A	V
X	E	R	Q	R	U	R	G	S	D	S	P	I	N	E	Y	O	R	B
T	U	P	J	U	W	D	N	V	W	S	L	E	I	E	R	M	D	I
R	Y	H	L	R	F	P	C	H	F	L	K	H	U	R	I		I	U
G	R	I	N	D	Y	D	X	R	G	A	R	C	L	B	U	O	P	T
R	I	S	T	P	M	B	V	K	F	M	D	T	D	Z	J	U	M	P
X	C	I	K	X	G	E	L	W	K	C	F	H	B	D	R	K	J	B
I	M	E	L	D	R	O	P	H	C	H	R	T	C	N	X	G	M	L

- ~~SPINE~~
- SKATEBOARD
- BIKE
- OLLIE
- BUNNY HOP
- GRIND
- AIR
- SKATEPARK
- DROP
- JUMP
- VERT
- SLAM
- DUGOUT

Color Me!

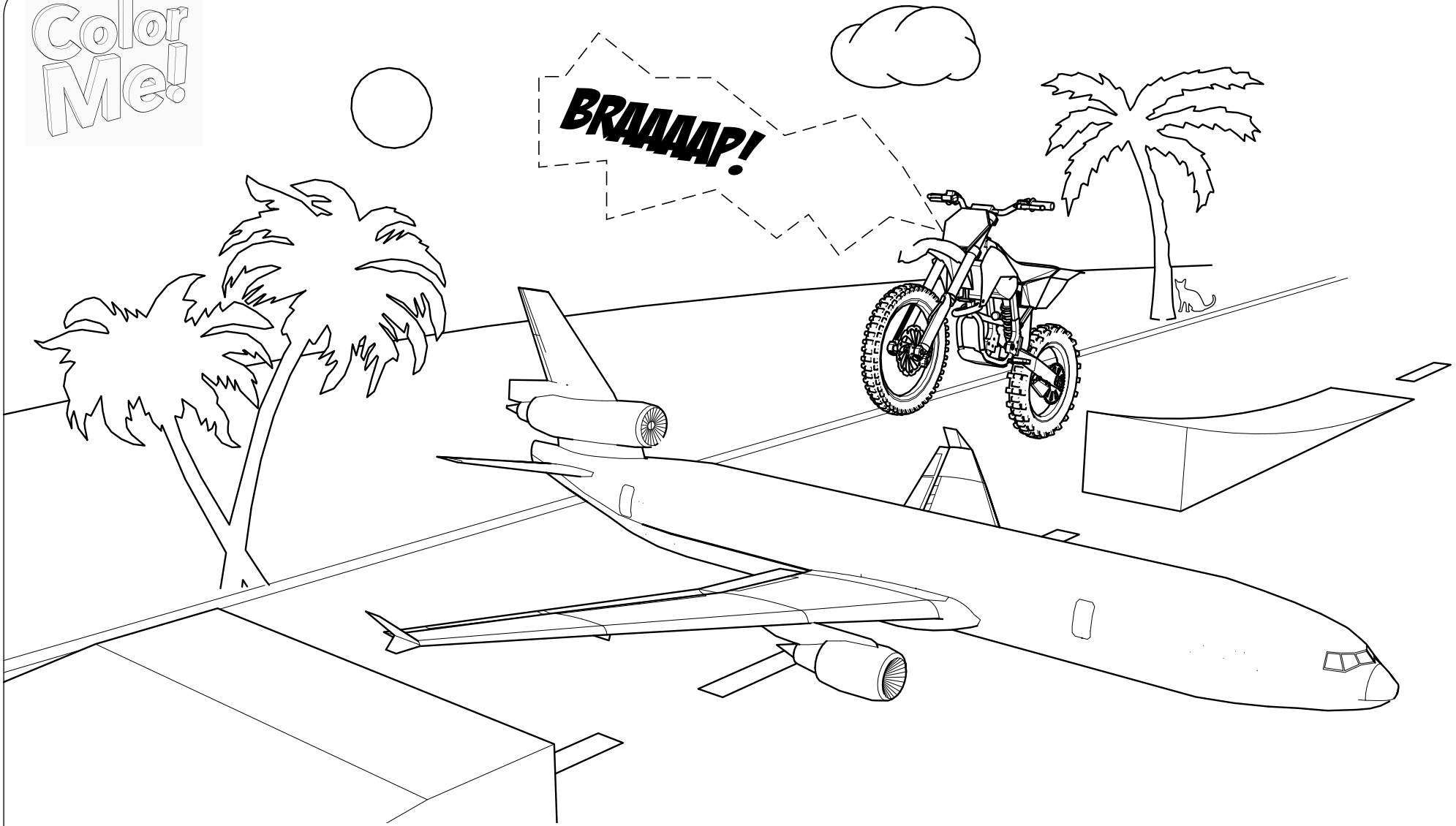

# AIRPLANE GAP



Color Me!

**DUGOUT.**  
designstudio

# NATURE PARK

© 2020 DugOut Design Studio, LLC. All Rights Reserved.



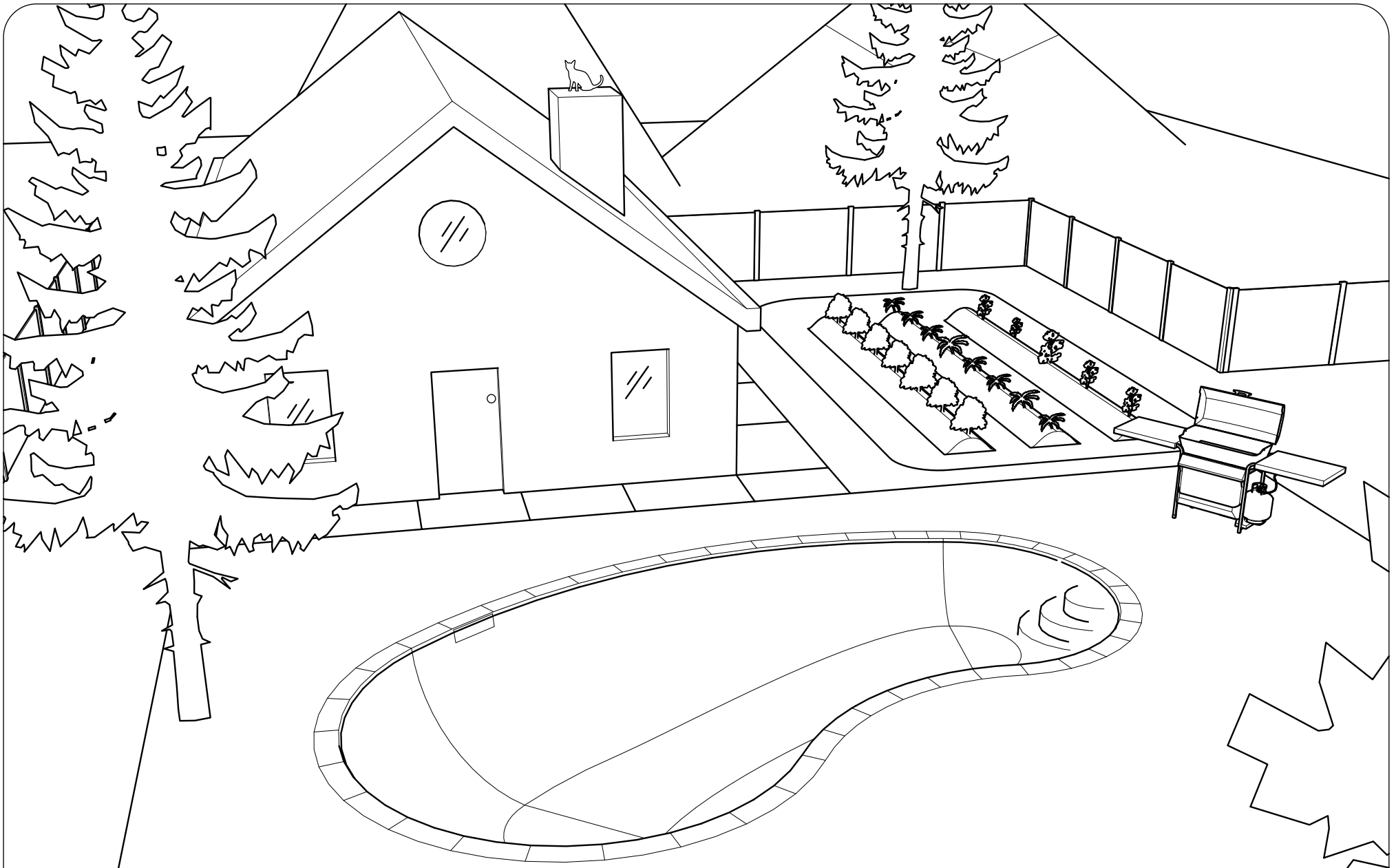

# BACKYARD BOWL

Color Me!



**DUGOUT.**  
designstudio

# STAIR SET WITH HUBBAS AND RAILS

© 2020 DugOut Design Studio, LLC. All Rights Reserved.

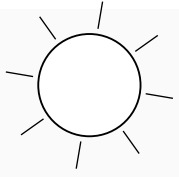

Color Me!

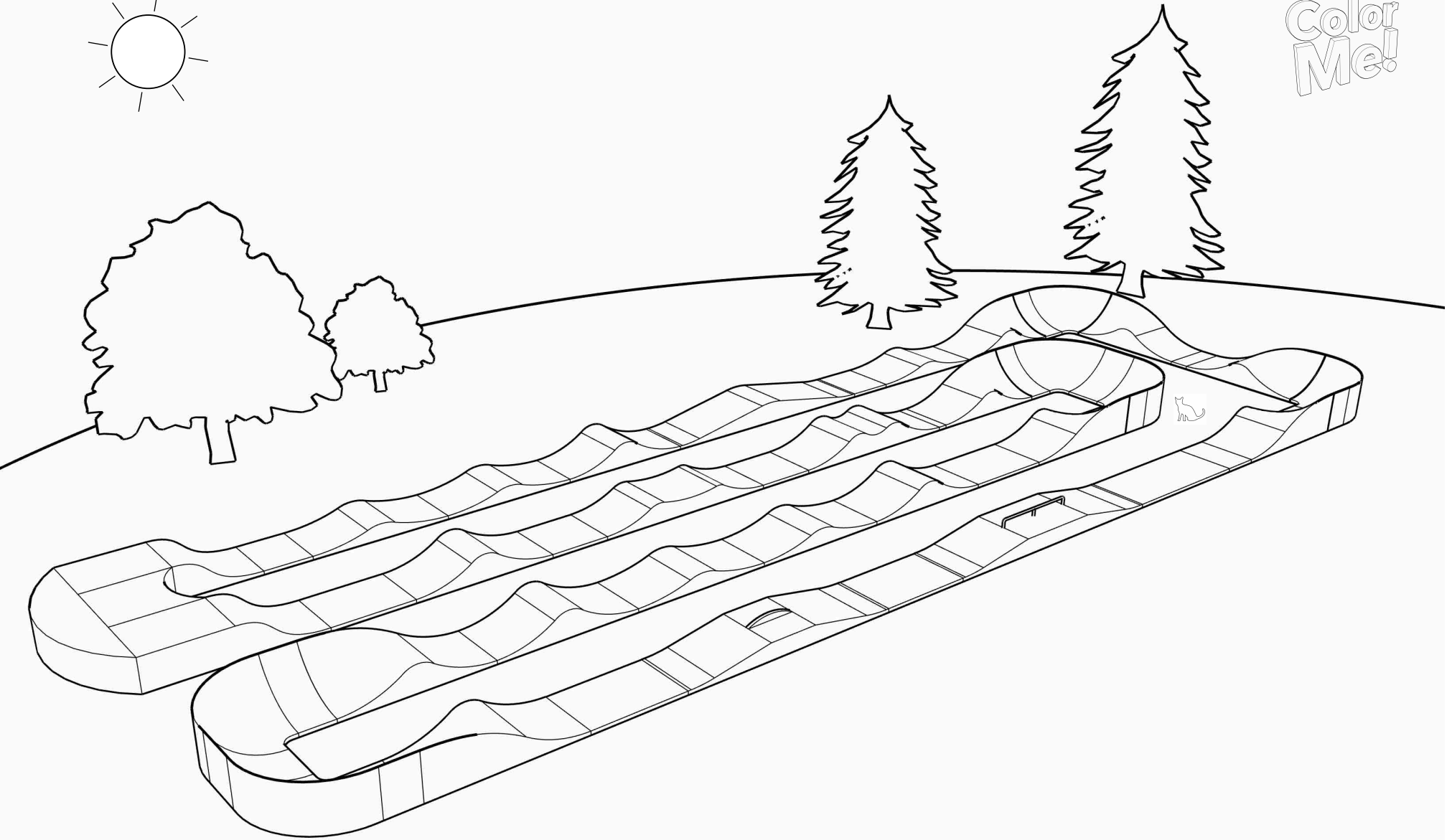

**DUGOUT**  
designstudio

# PUMP TRACK

© 2020 DugOut Design Studio, LLC. All Rights Reserved.

**OOPS, YOUR BOARD ROLLED  
INTO THE BOWL! TRY TO FIND  
IT IN ALL THE LINES.** 

**DROP IN**

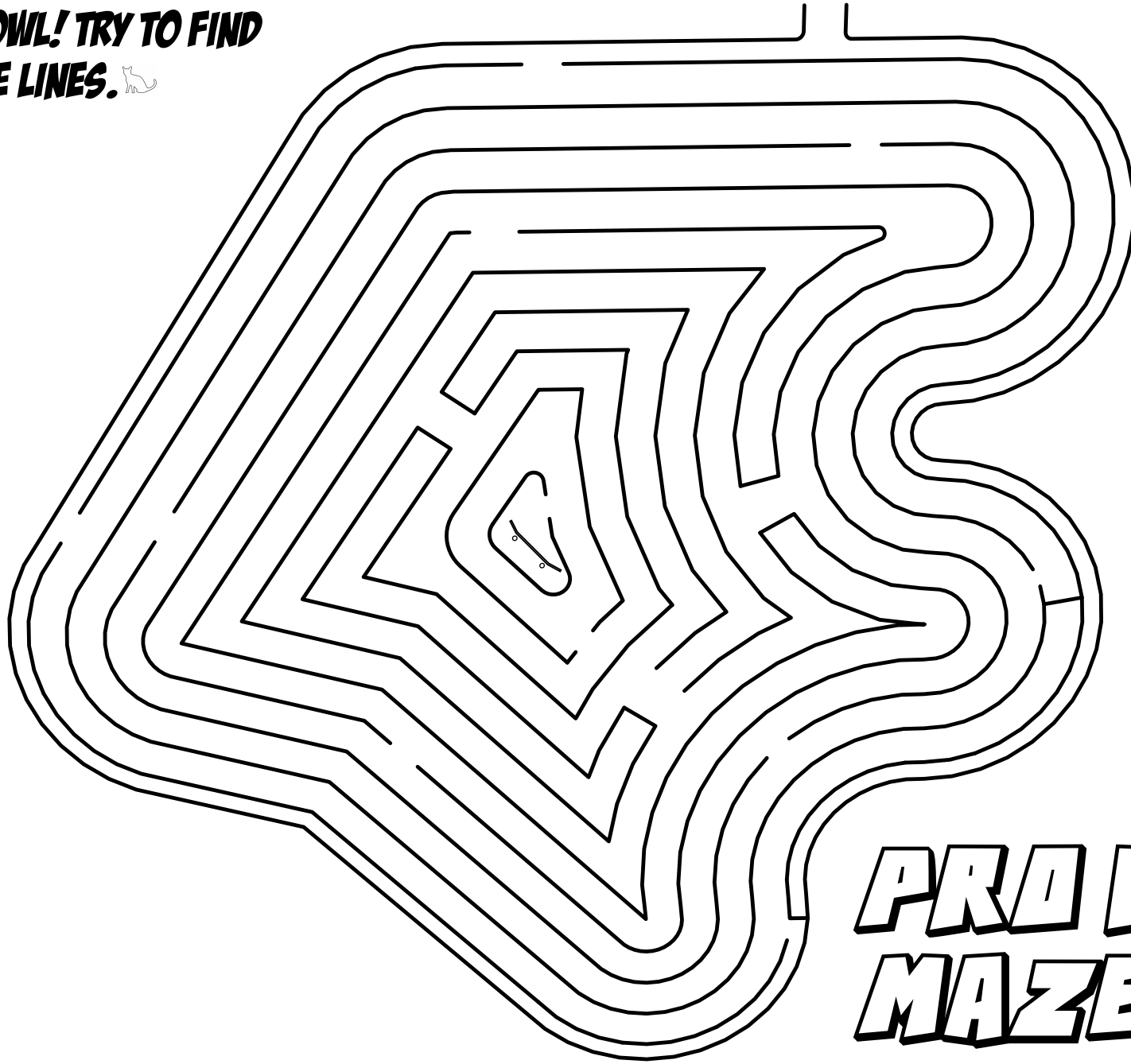

**PRO BOWL  
MAZE**

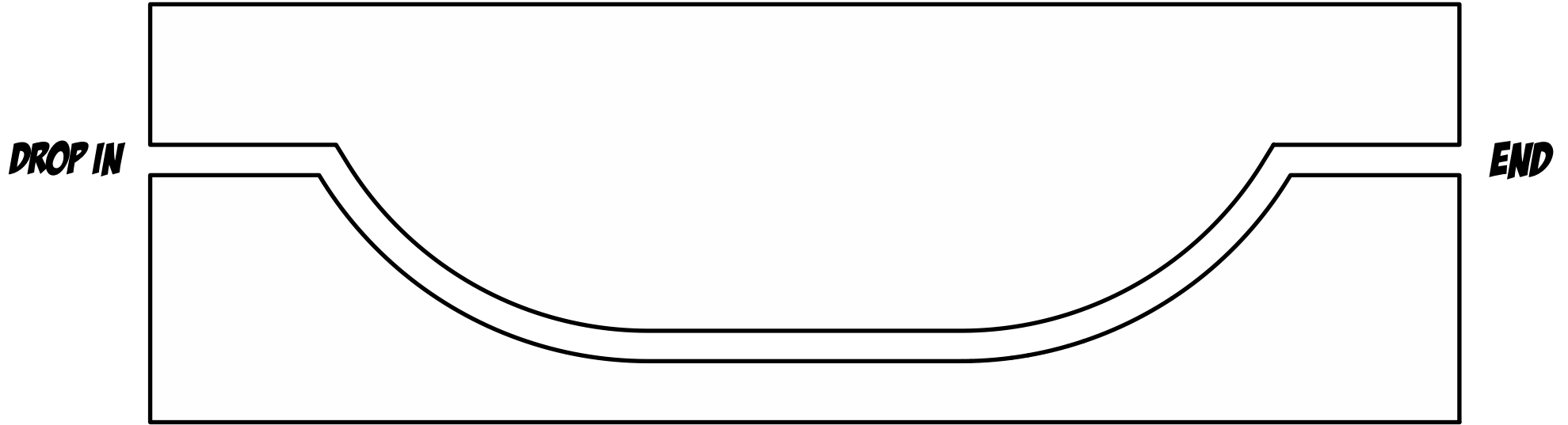

# **BEGINNERS MINI-MAZE**

# CONNECT THE DOTS

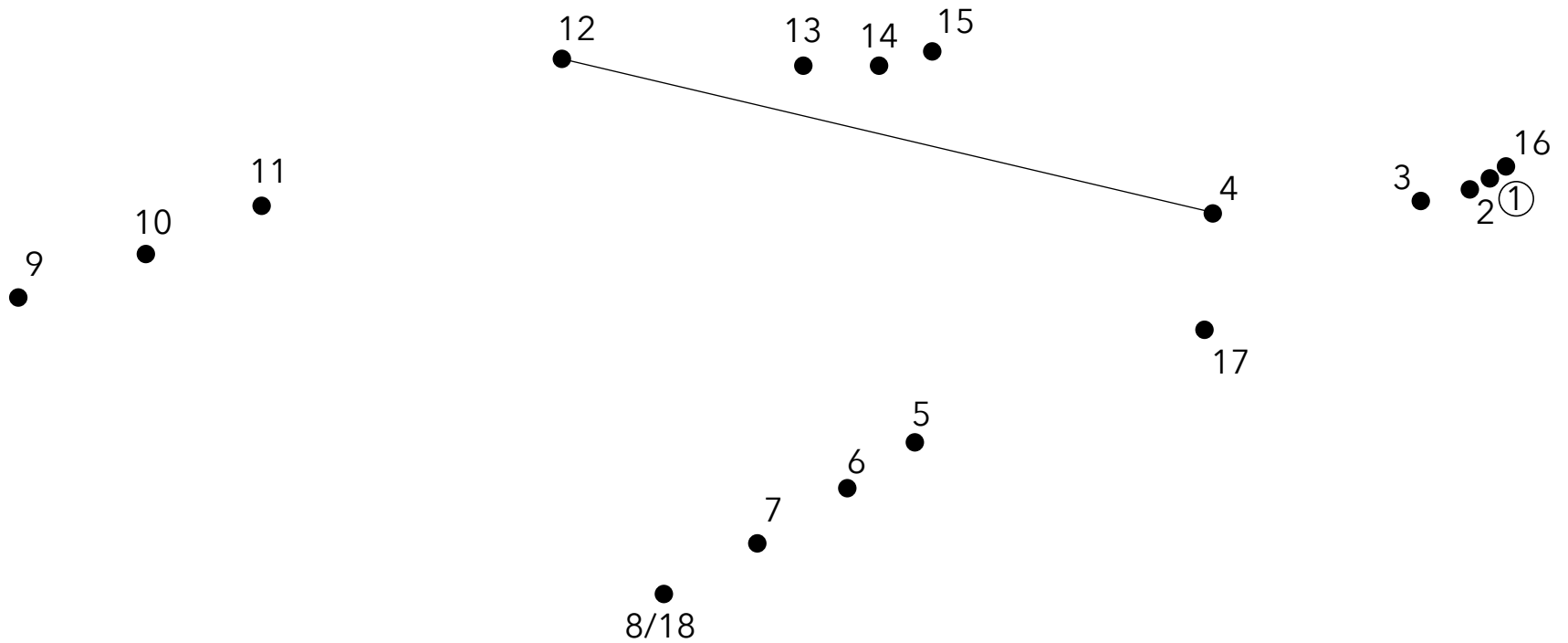

## DRAW IN 3D: A-FRAME RAMP

# CONNECT THE DOTS

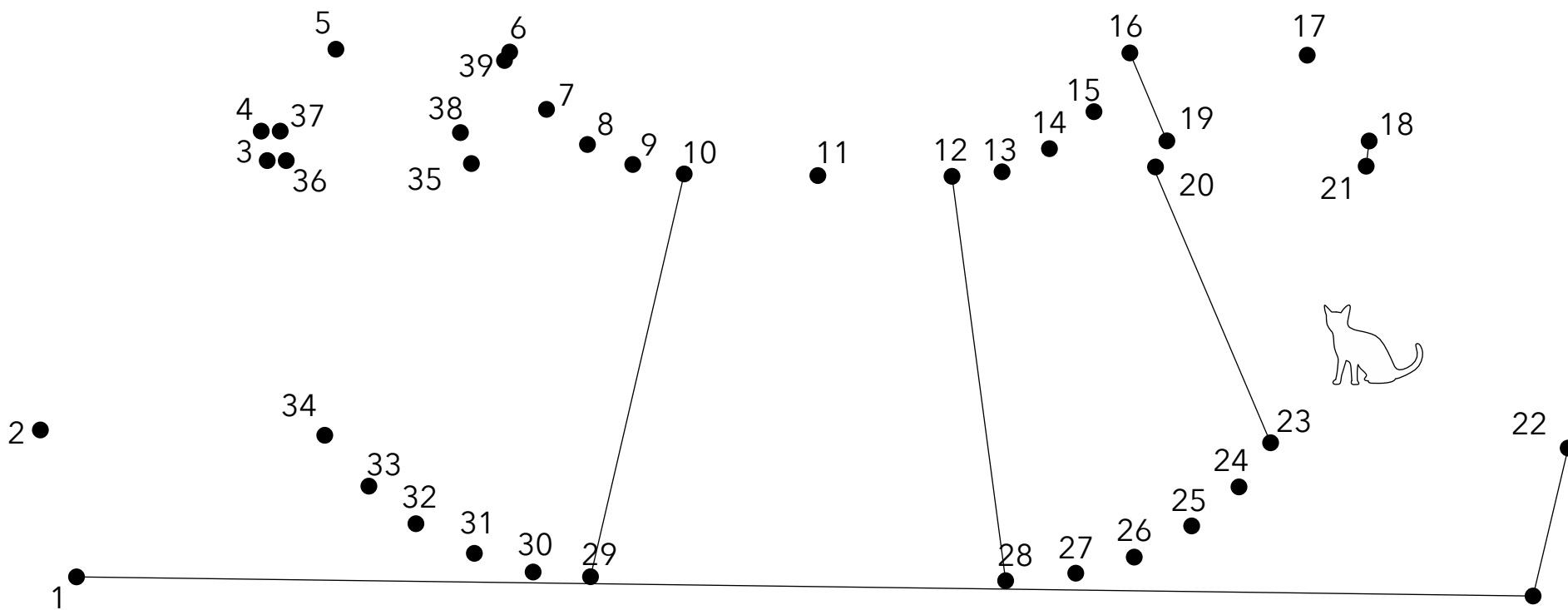

## ***DRAW IN 3D: MINIRAMP***

# SEARCH AND FIND

CAN YOU FIND THESE SKATEPARK FEATURES?

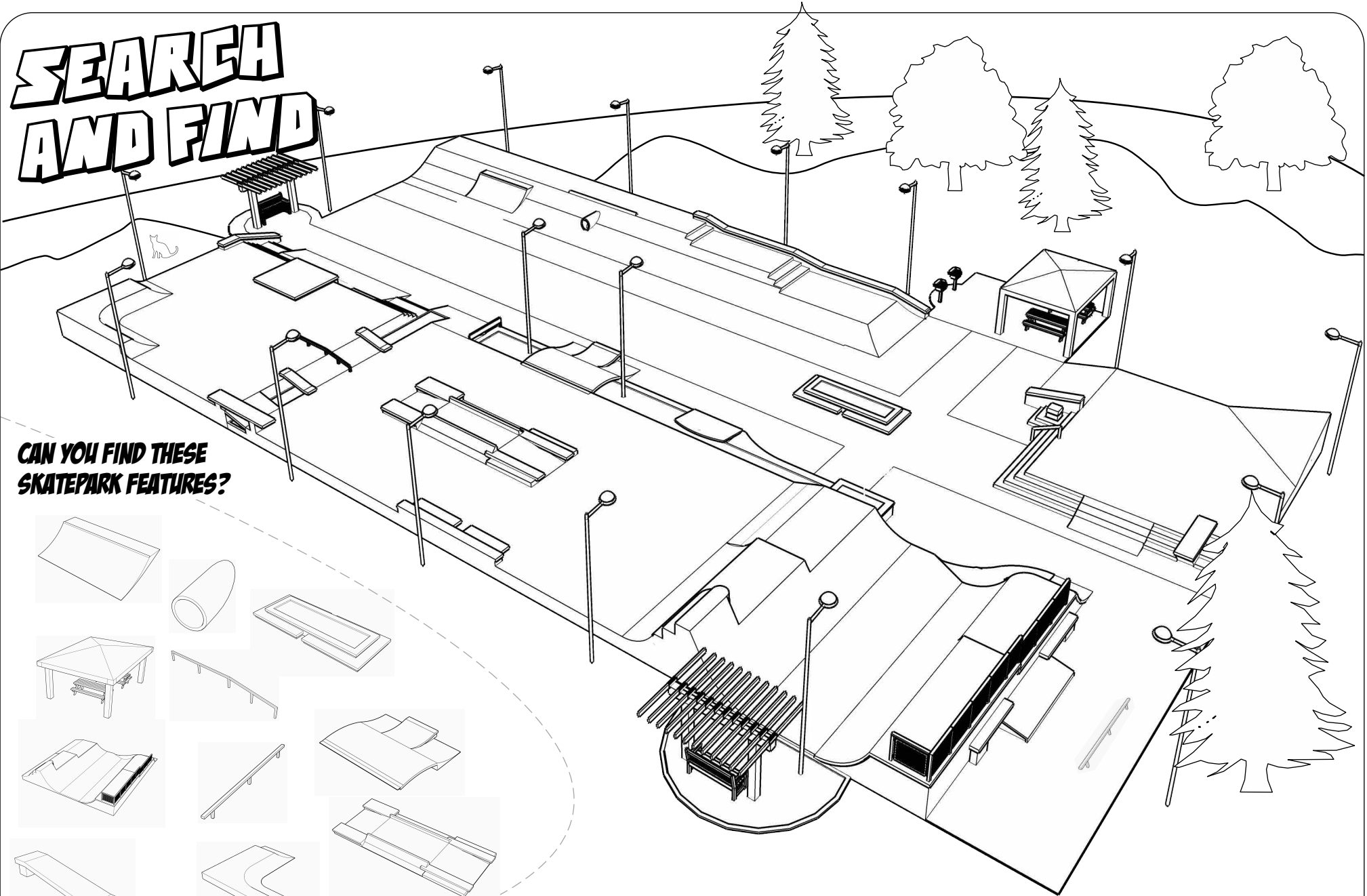
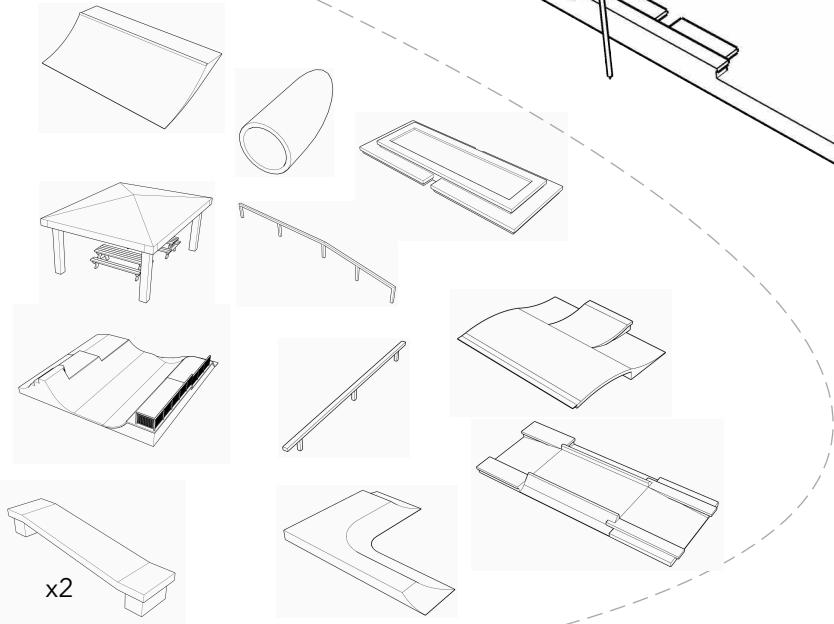



# LEARN TO CALCULATE SQUARE FOOTAGE

Sometimes when we design skateparks, we need to first figure out how big of an area we are going to build in, that way we can estimate how much the skatepark will cost.

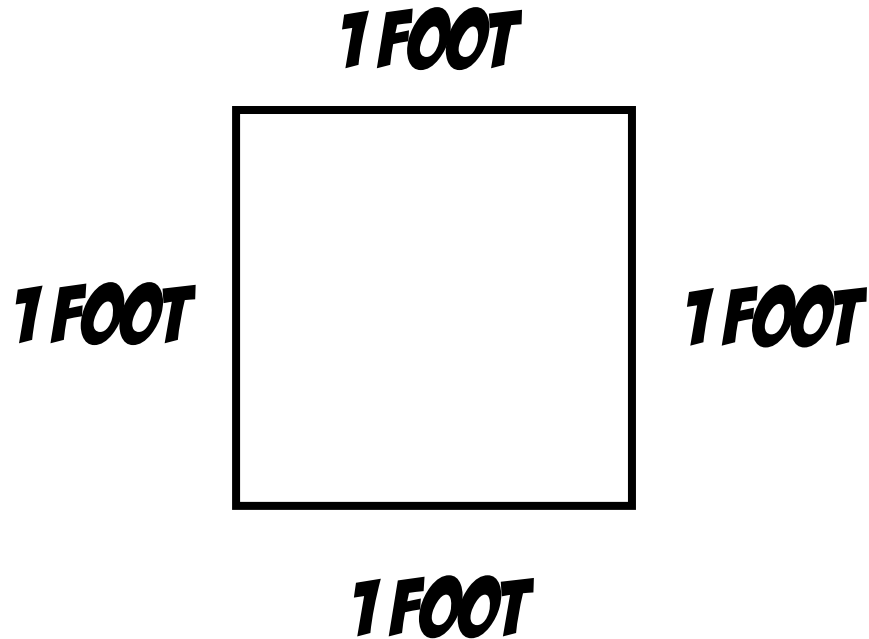

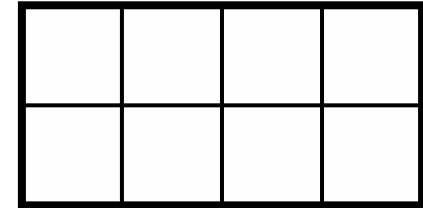

**THIS BOX = 1 SQUARE FOOT**

## COUNT THE SQUARES

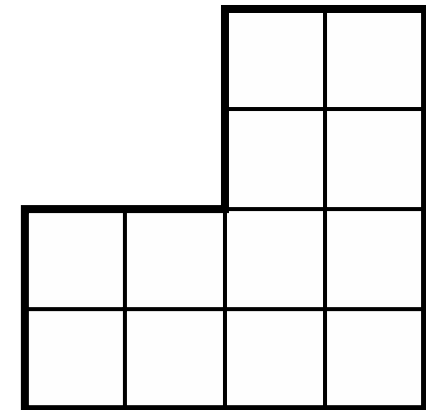

Total Square Feet: \_\_\_\_\_



Total Square Feet: \_\_\_\_\_ 

# LEARN TO CALCULATE SQUARE FOOTAGE (LIKE A PRO)

Sometimes when we design skateparks, we need to first figure out how big of an area we are going to build in, that way we can estimate how much the skatepark will cost.

**LENGTH**

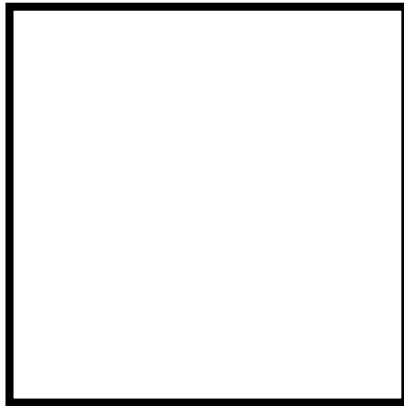

**WIDTH**

**LENGTH X WIDTH = SURFACE AREA**

# MULTIPLY LENGTH X WIDTH

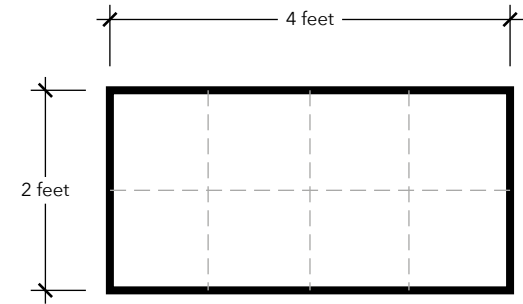

**Total Square Feet:** \_\_\_\_\_

**Hint:**  $4 \times 2 =$

**\*Count the squares to check your math**

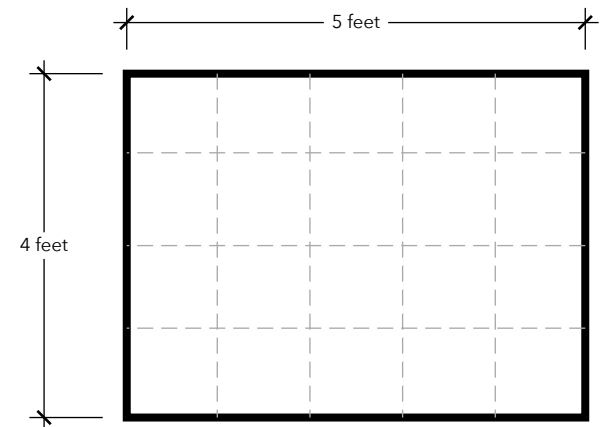

**Total Square Feet:** \_\_\_\_\_

# DESIGN YOUR OWN SKATEPARK

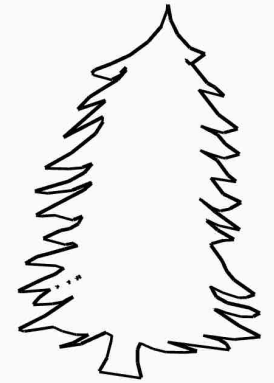
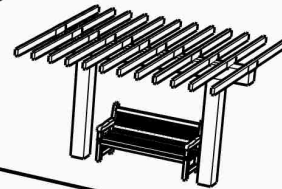
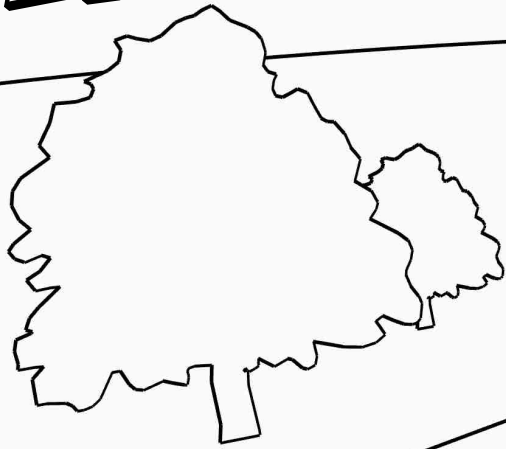
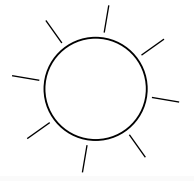

# 3D PAPER MODEL CUT-OUT QUARTERPIPE

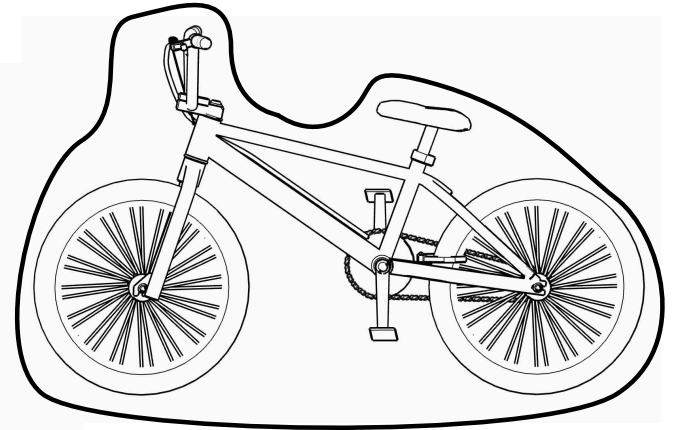
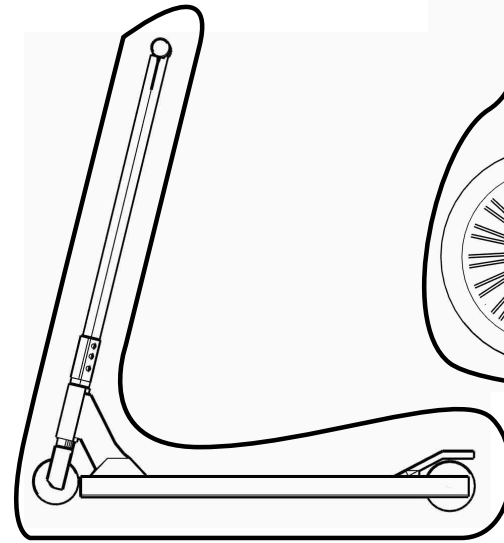
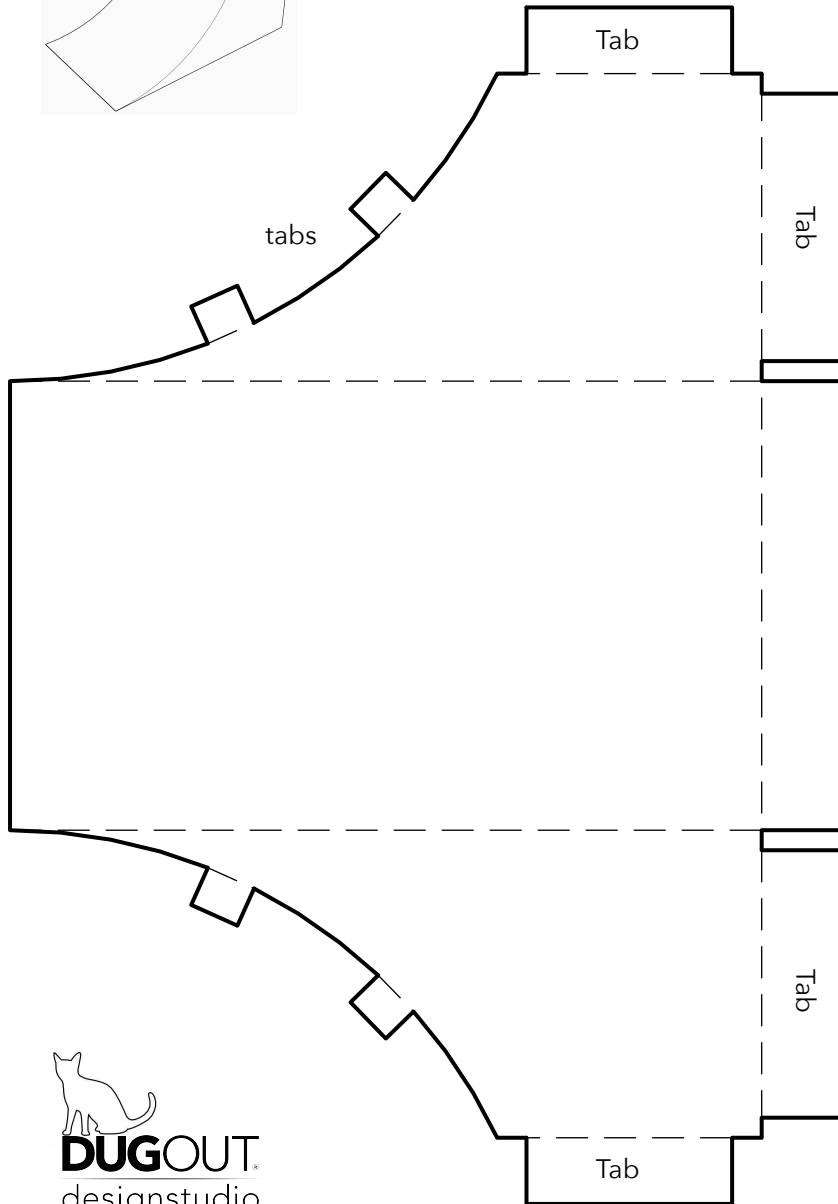
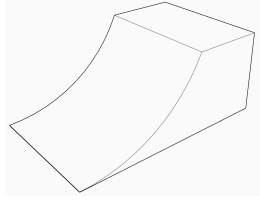

Cut along solid line, fold along dotted lines

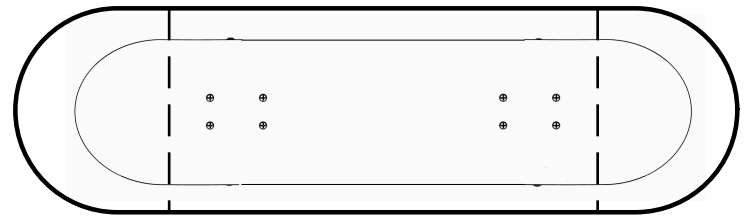

# 3D PAPER MODEL CUT-OUT

## GRIND BOX

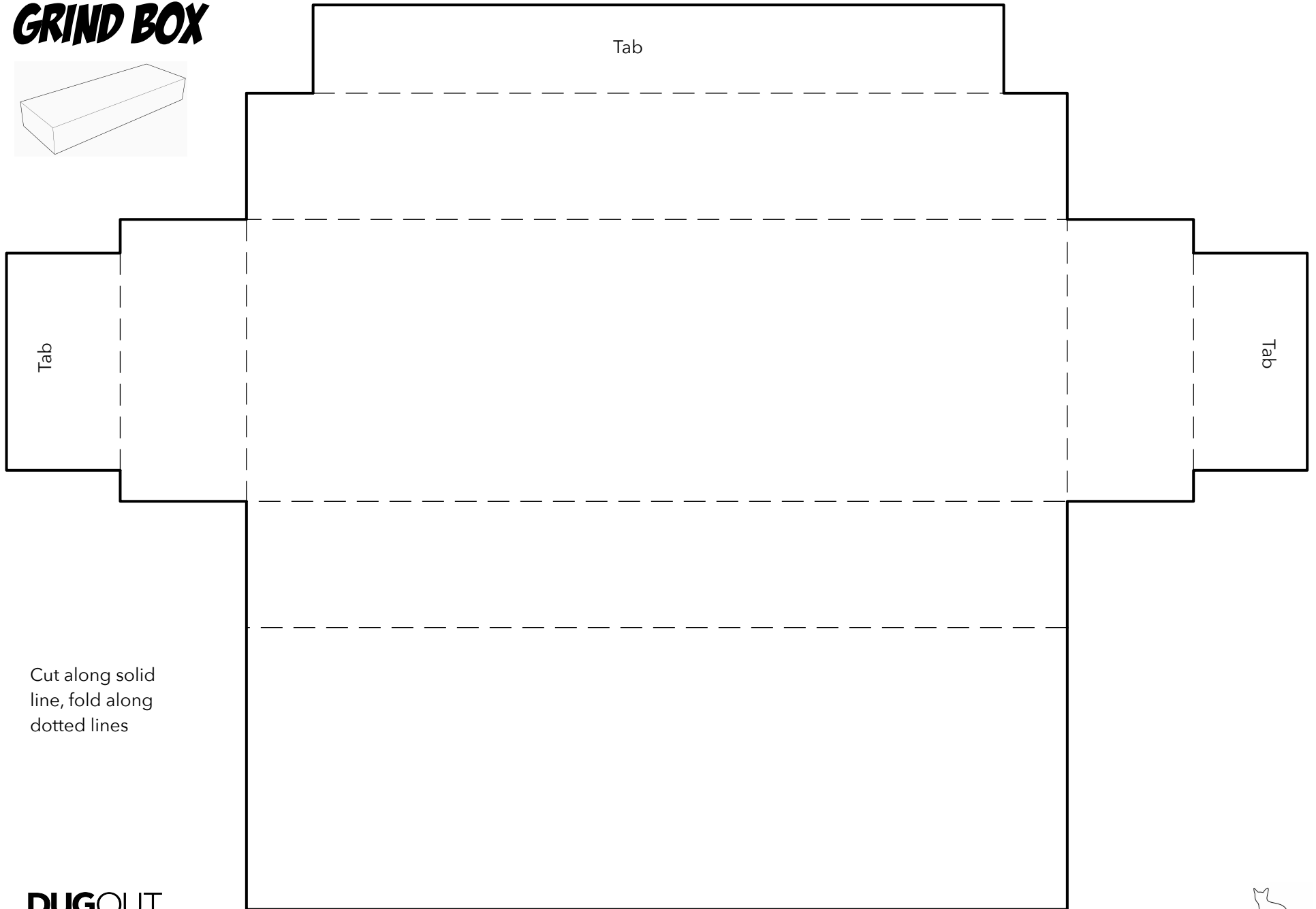
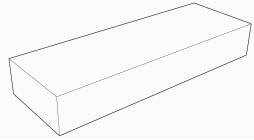

Cut along solid  
line, fold along  
dotted lines



**DUGOUT**<sup>®</sup>  
designstudio

# **CERTIFICATE OF ACHIEVEMENT**

## **THIS IS TO CERTIFY THAT**

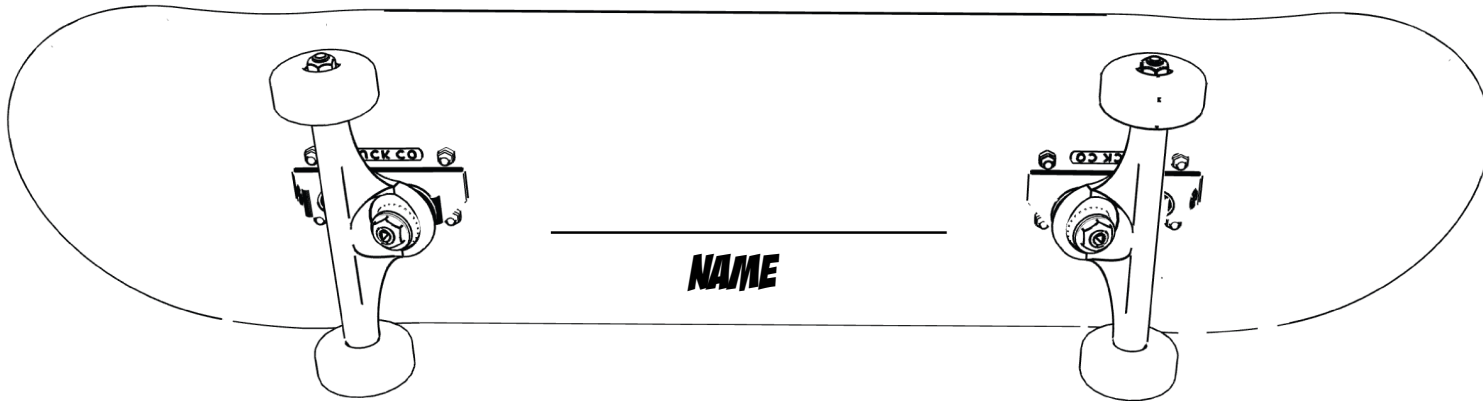

**NAME**

**HAS COMPLETED THE FIRST STEPS TO  
BECOMING A FUTURE SKATEPARK DESIGNER!**

**DATE**